

Impulse

SITS



Impulse

UPHOLSTERY



COMFORTS

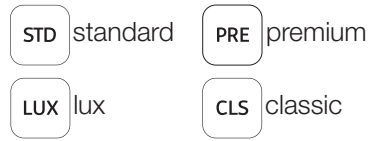

COVERS

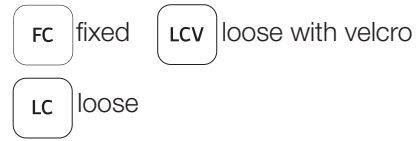

SPECIAL



Drawing show combinations with armrest I. Combinantons with other armrest are properly longer or shorter in width.

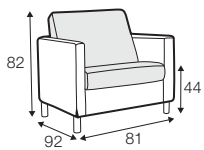

armchair

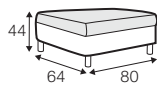

footstool 80x64

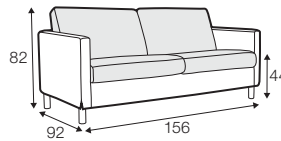

2 seater

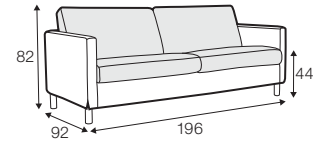

2,5 seater

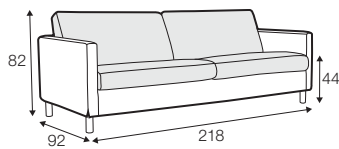

3 seater

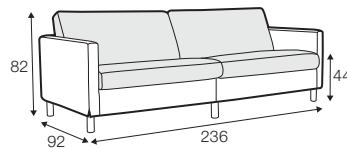

4 seater divided

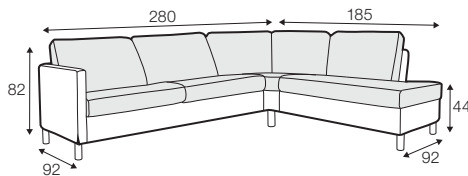

set 4 right / or left
2,5 seater left / or right + divan right / or left

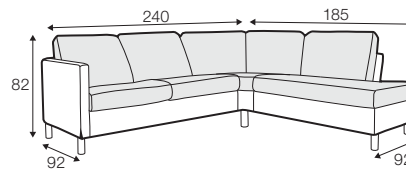

set 5 right / or left
2 seater left / or right + divan right / or left

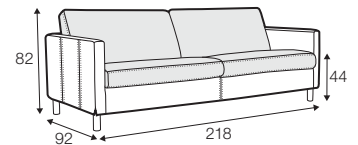

example of leather cover
3 seater

modular system

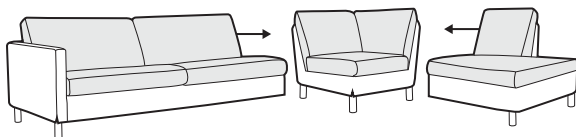

elements of the modular system

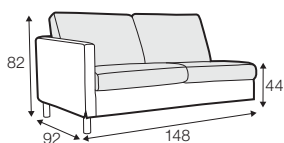

2 seater left / or right

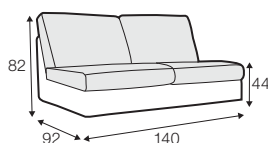

2 seater
without armrests

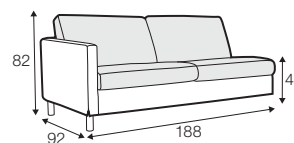

2,5 seater left / or right

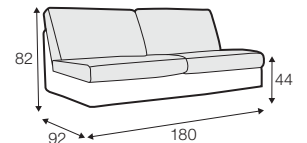

2,5 seater
without armrests

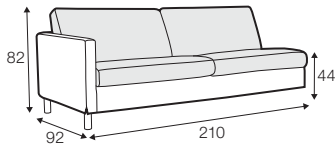

3 seater left / or right

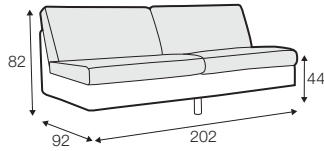

3 seater
without armrests

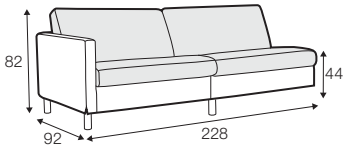

4 seater divided left / or right

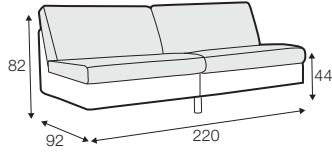

4 seater divided
without armrests

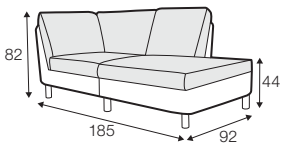

divan right / or left

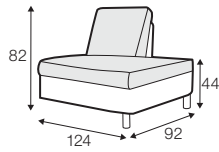

bench right / or left

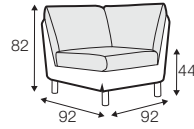

corner 90°

extra dimensions

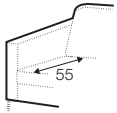

depth of seat

accessories

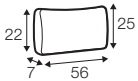

cushion

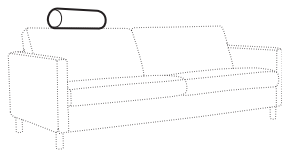

headrest with roll L-60

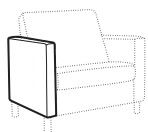
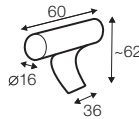

armrest I

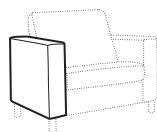
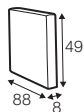

armrest II

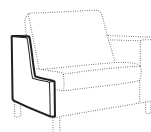
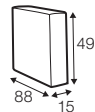

endpart left / or right



legs

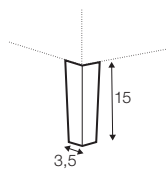

no. 109
wood

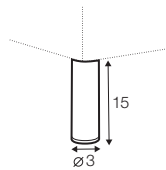

no. 111D
metal chrome,
painted black or grey
and brushed steel*

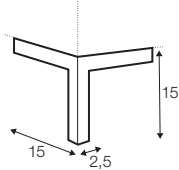

no. 124
metal chrome,
painted black or grey
and brushed steel*

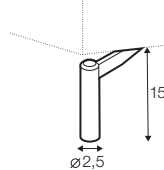

no. 145
metal chrome,
painted black or grey
and brushed steel*

All legs can be fixed to both armrests:

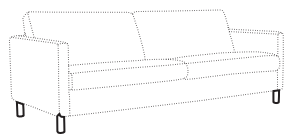

under armrest

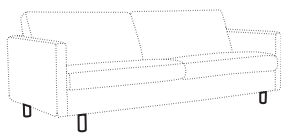

under frame

profile

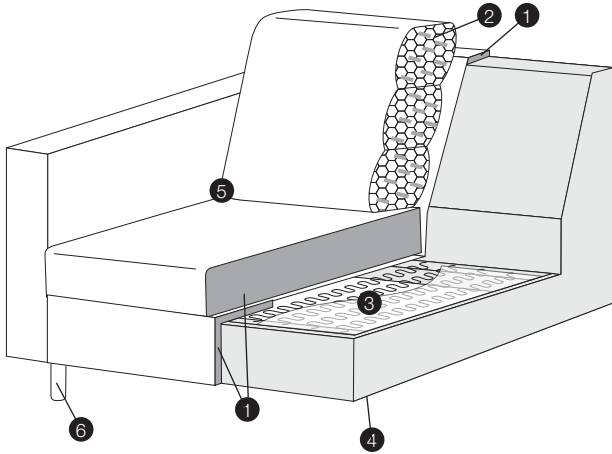

standard

1. polyurethane foam/ high resilient polyurethane foam
2. foam flakes with silicone balls
3. springs
4. FSC® certified solid wood and wood based elements
5. fabric or leather
6. FSC® certified solid wood or metal legs

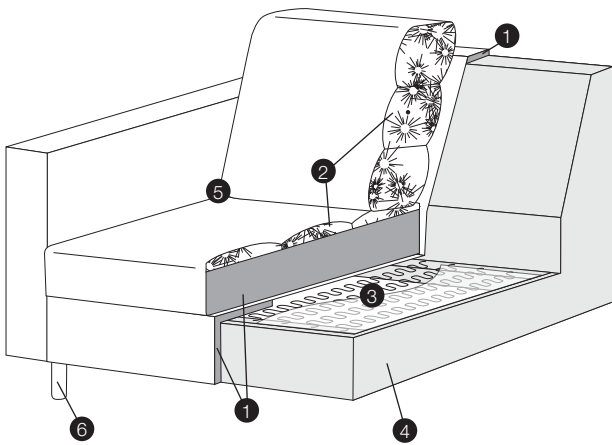

lux

1. polyurethane foam/ high resilient polyurethane foam
2. cushion chamber with mix of feather and silicone balls
3. springs
4. FSC® certified solid wood and wood based elements
5. fabric or leather
6. FSC® certified solid wood or metal legs

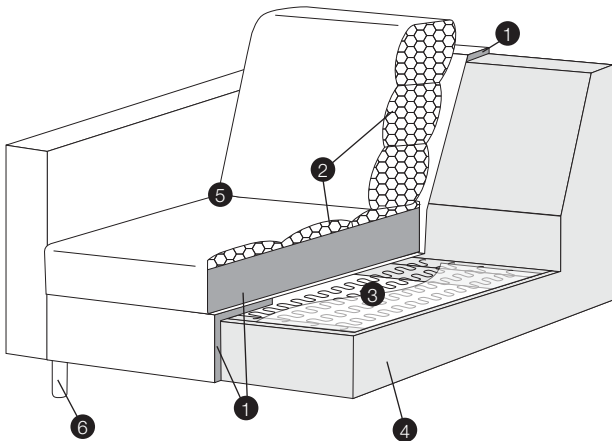

premium

1. polyurethane foam/ high resilient polyurethane foam
2. silicone balls
3. springs
4. FSC® certified solid wood and wood based elements
5. fabric or leather
6. FSC® certified solid wood or metal legs

profile

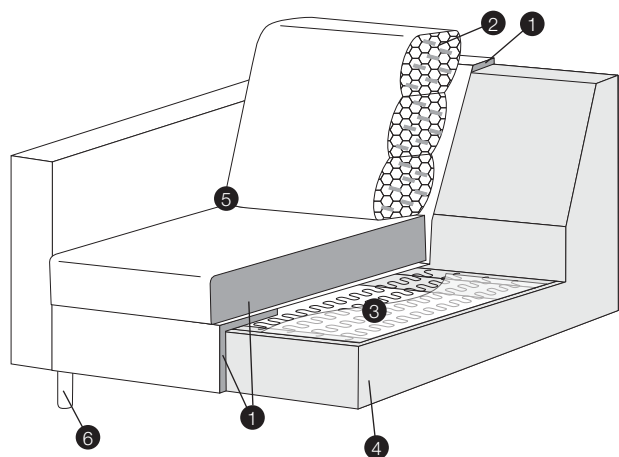

classic

1. polyurethane foam/ high resilient polyurethane foam
2. foam flakes with silicone balls
3. springs
4. FSC® certified solid wood and wood based elements
5. fabric or leather
6. FSC® certified solid wood or metal legs

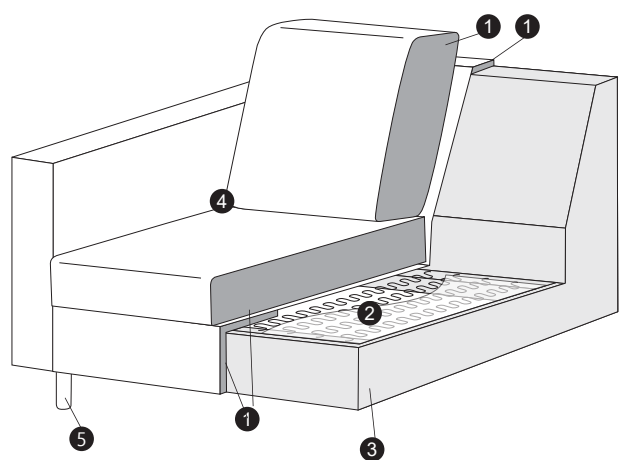

plus

1. polyurethane foam/ high resilient polyurethane foam
2. springs
3. FSC® certified solid wood and wood based elements
4. fabric or leather
5. FSC® certified solid wood or metal legs