

Maja

SITS



Maja

UPHOLSTERY

COMFORTS

COVERS



fabric



STD standard



FC fixed

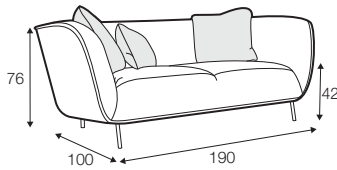

2 seater

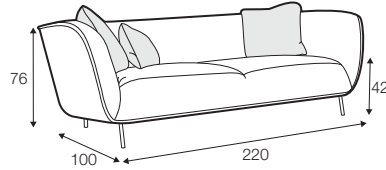

3 seater

extra dimensions

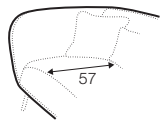

depth of seat

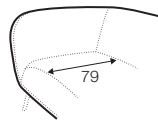

depth of seat
without cushions

legs

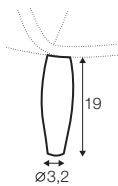

no. 164
wood
front

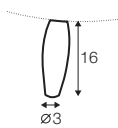

no. 164A
wood
back

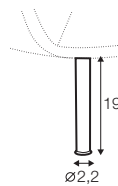

no. 165
metal chrome,
painted black or grey,
brass gold
and brushed steel*
front

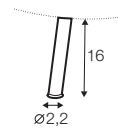

no. 165A
metal chrome,
painted black or grey,
brass gold
and brushed steel*
back

*please check a cost of brushed steel finish with a sale representative

profile

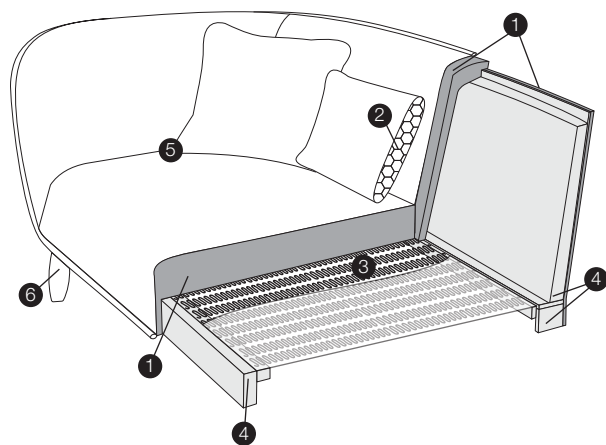

standard

1. polyurethane foam/high resilient polyurethane foam
2. silicone balls
3. springs
4. FSC® certified solid wood and wood based elements
5. fabric
6. FSC® certified solid wood or metal legs